

TEST DATA

ITEM	SPEC	SAMPLE									
		1	2	3	4	5	6	7	8	9	10
Primary Exciting Current Input 230 VAC ,50 Hz	60 mA max	24	25	26							
Primary Load Current Input 230 VAC ,50 Hz	130 mA max	79	78	78							
Secondary No Load DC Voltage	15.5V ±5%	15.5	15.42	15.4							
Secondary DC Voltage Load 800 mA	12V ±5%	12.1	12.12	12.02							
Secondary Voltage Load mA	V ± %										
Secondary Voltage Load mA	V ± %										
Secondary Voltage Load mA	V ± %										
Secondary Voltage Load mA	V ± %										
Ripple Voltage Load 800 mA (PK-PK)	2.5V max	2	2	2							
Hi-Pot Test 3 mA for 3SEC	Pri. to Sec.	4K VAC	OK	OK	OK						
	Pri. to Core	4K VAC	OK	OK	OK						
	Sec. to Core	3K VAC	OK	OK	OK						
Temperature Rise: 70°C MAX measured By Resistance Method (Primary Winding)											
Core Film: SPLIT						Core : EI-48					
Testing Circuit:		2200uF/25V				Output Plug Drawing: PLUG:5.5*2.1mm					
											
Output conductor length: 6FT min (AWG#22)											
Input conductor length: FT min (AWG#)											
(V) Characteristic Curve											
											

AC Adaptor Specifications

Internal Construction Drawing and Parts List (Unit: Set or EA)

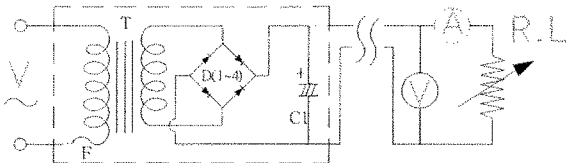
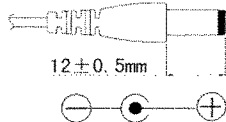
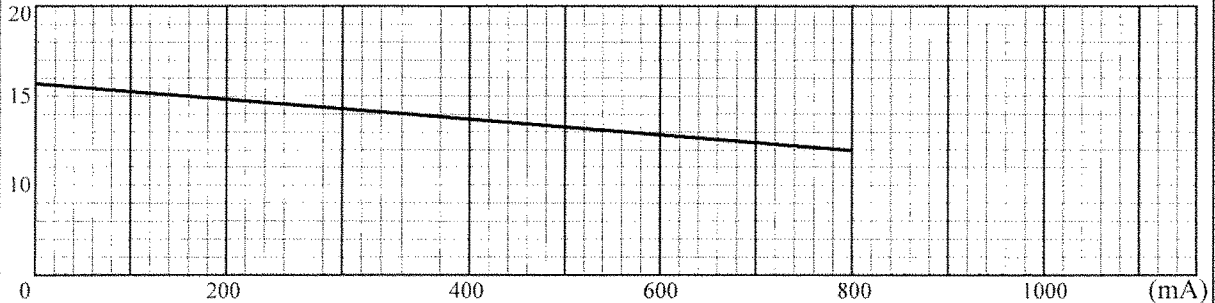
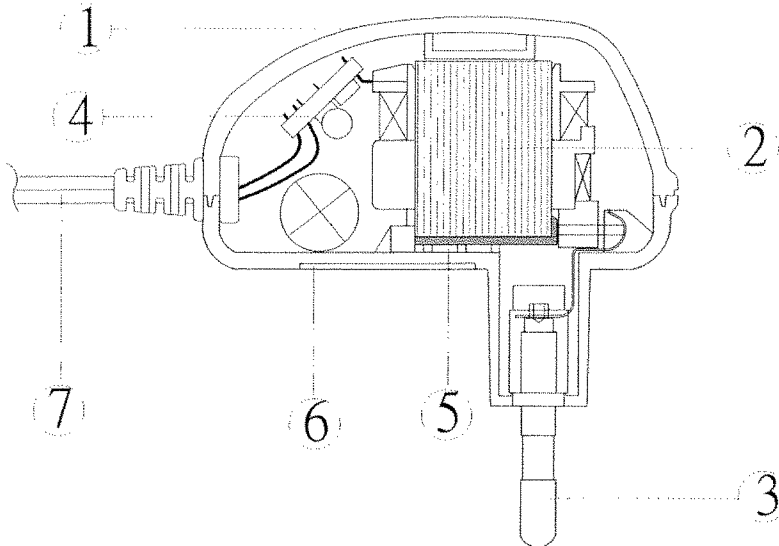

Part Name	Specification	Q'ty
1. Enclosure	Noryl SE1 94V-0 105°C	
	Noryl SE-100 94V-0 95°C	
	Noryl PX1700 94V-0 95°C	
	940(f1) 94V-0 130°C	
2. Transformer	EI-48	1
3. Blade	Ni plated brass	2
4. Print Wiring Board Assembly		
Print Wiring Board	04V0 94V-0 130°C	1
	11 94V-0 105°C	
	13 94V-0 130°C	
	BF-3 94V-0 130°C	
Diode	1A 400-700V IN4004-IN4007	4
Capacitor	2200uf 25V 85°C	1
5. Insulation Layered	Noryl PX1700 94V-1 95°C	1
6. Name Plate	Polyester Film	1
7. Output Cord	AWG# 22 6FT min	1



AC Adaptor Specifications

Construction Drawing and Details of Transformer

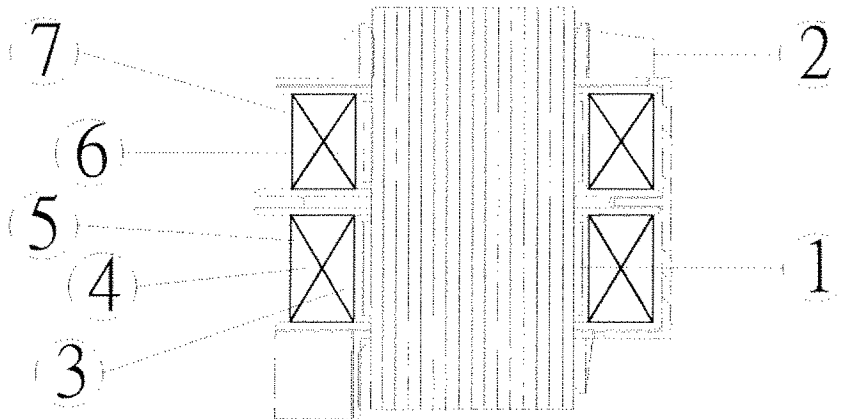

Part Name	Material & Type	Spec or Q'ty
1. Core	Silicon Steel	0.5mm
2. Bobbin	Polybutylene Terephthalate	0.71mm
	1403G6	
	PETP(QMFZ2)	
	FR-530, FR530L	
3. Primary Winding	Polyurethane Enameled	mm turn ohm
	Copper wire	
4. Primary Outer Winding	Mylar Tape	0.025mmx2T
5. Thermal Fuse	T2 2A 125°C 250V AC	IPC
	K3 2A 125°C 250V AC	
	A3 2A 125°C 250V AC	
6. Secondary Winding	Polyurethane Enameled Copper Wire	mm turn ohm
7. Secondary Outer Winding	Mylar Tape	0.025mmx2T

AC Adaptor Specifications

Circuit Diagram

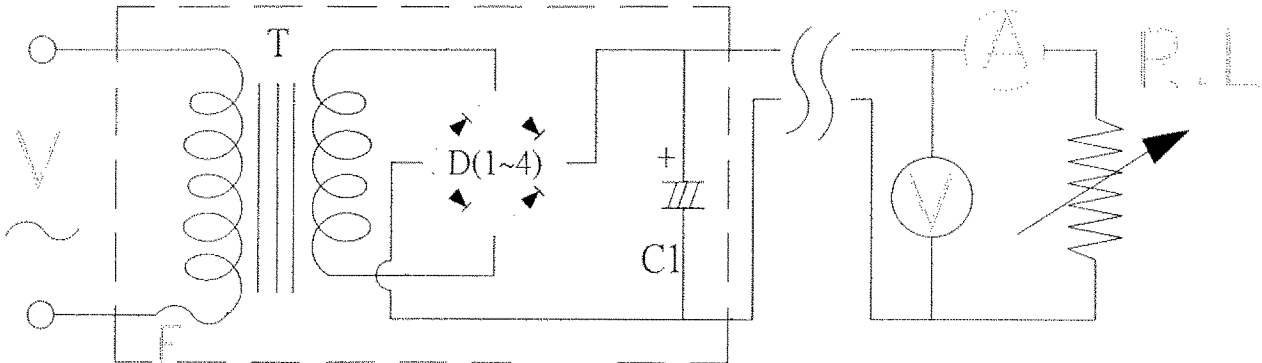

Symbol	Part Name	Note
T	Transformer	EI-48
D(1~4)	Diode	1A 400-700V IN4004-IN4007
C1	Capacitor	2200uF 25V 85°C
F	Thermal	125°C 2A 250V

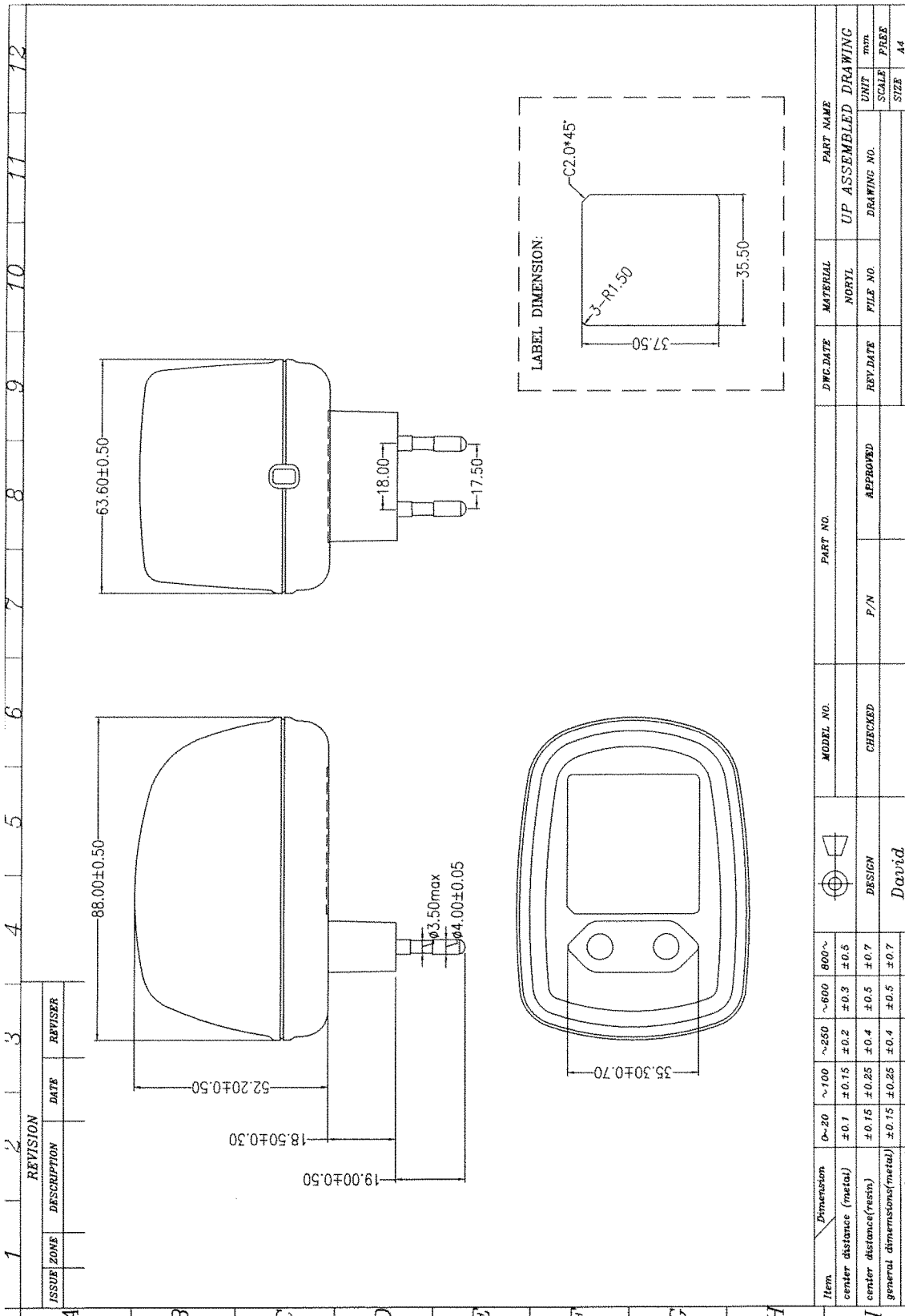

AC Adaptor Specifications

Dimension of Nameplate (Unit:mm)

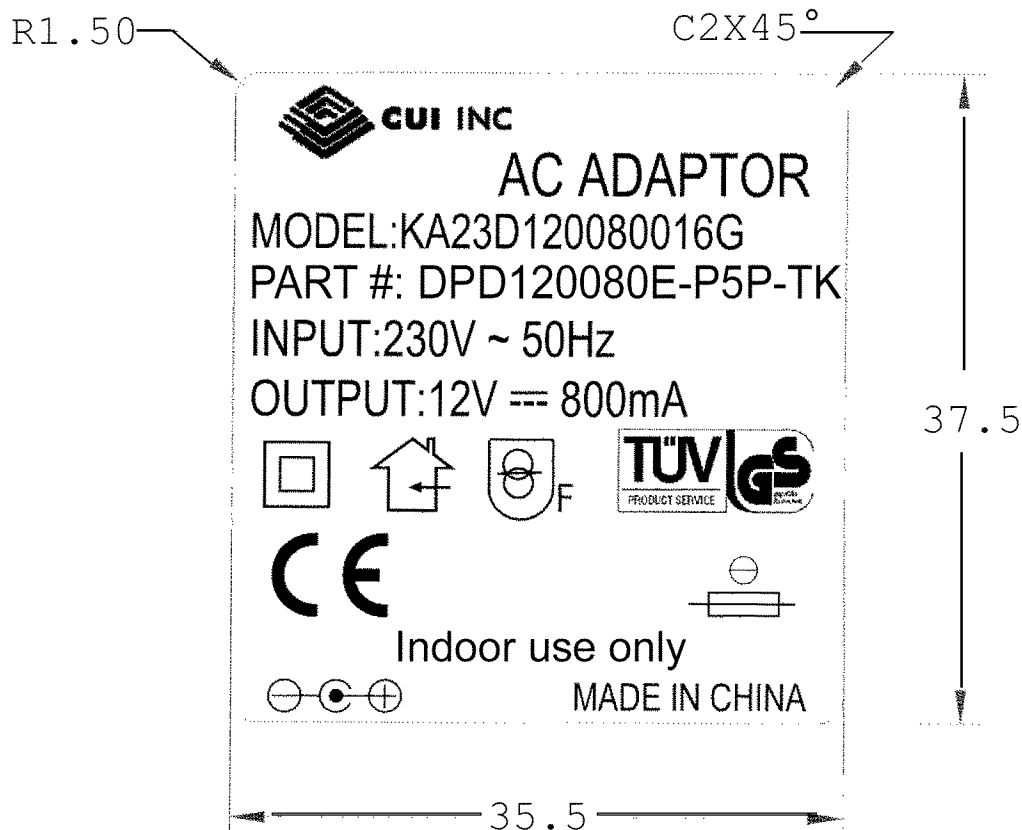

Material: Polyester Film

T: 0.25mm